

OPERATION, SERVICE AND PARTS MANUAL

TUGIT®

LEVER OPERATED HOISTS

PROTECTED BY U.S. PATENT 3,047,114
ALSO PATENTED IN CANADA 1952 & 1963

1-1/2 AND 3 TON
CAPACITIES

FOR MODELS
503700 THRU **503705** ,
503639 , **505110** AND **505111**

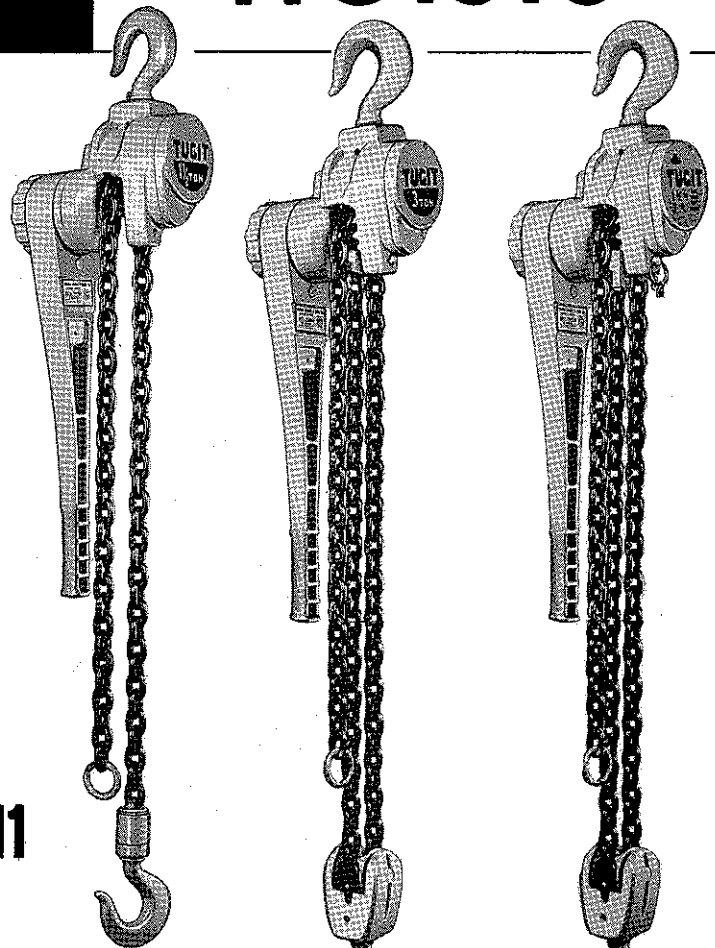

1-1/2 TON MODEL

3 TON MODEL

1-1/2 TO 3 TON
CONVERTIBLE
MODEL

CRANE & HOIST OPERATIONS
MUSKEGON, MICHIGAN 49443

**DRESSER
INDUSTRIES**

DRESSER

DRESSER INDUSTRIES, INC.

FOREWORD

This book is designed to help you operate, maintain and service your 'Tugit' Lever Operated Hoist. Study its contents thoroughly before attempting operation. Then by applying correct operating procedures and practicing the helpful maintenance suggestions, you will be assured optimum performance and years of trouble-free service.

It will likely be a long time before you will need the repair and parts information included, so carefully file this book for future reference.

Section	INDEX	Page
	1-1/2 & 3 TON STANDARD MODELS	
I	GENERAL DESCRIPTION	2
II	OPERATION	2
III	LUBRICATION	3
IV	MAINTENANCE	4
V	TROUBLE SHOOTING	4
VI	DISASSEMBLY & REASSEMBLY	5
VII	PARTS LIST	10
	3 TON CONVERTIBLE MODEL	
VIII	INSTRUCTIONS FOR CONVERTING	13
IX	PARTS LIST	14

SECTION I - GENERAL DESCRIPTION

1-1. 'Tugit' Lever Operated Hoists are precision built spur geared type hoists, especially designed for close quarter lifting, pulling and stretching. They are operated by a handle instead of the usual handchain and wheel.

1-2. 'Tugit' hoists are made in five sizes: 3/4, 1, 1-1/2, 2 and 3 ton capacities; with lifts ranging from 4' 6" to 25'. Each size is available with plain or safety hooks and in standard or spark and corrosion resistant models.

NOTE: This book contains operating, service and parts information on the 1-1/2 and 3 ton capacity hoist models, including convertible models, as noted on front cover (Models 503639 and 503700 thru 503705). These numbers will be found stamped on a metal nameplate attached to the 'Tugit' handle. Prior 1-1/2 and 3 ton models (Models 502378 thru 502395, 503081 thru 503088 and 503434) and all 3/4, 1 and 2 ton capacity hoists are covered by separate books. The information contained in Sections I thru VII is also applicable to the 3 ton convertible model covered in Sections VIII and IX. INFORMATION CONTAINED IN THIS BOOK IS SUBJECT TO CHANGE WITHOUT NOTICE.

1-3. The 1-1/2 and 3 ton capacity 'Tugit' hoists are basically the same, having common frames, operating mechanisms, and operating handles. They differ only in hook size and chain reeving. On 1-1/2 ton models the lower hook is suspended on a single part of load chain; two parts on 3 ton model. The 3 ton convertible model has a quick-disconnect dead end chain anchor which facilitates changing from 3 ton double-line to 1-1/2 ton single-line chain reeving (see Section VIII). Frames are aluminum alloy; load chains are link type, of special heat treated alloy steel; hooks are forged steel, designed to open slowly when overloaded.

SECTION II - OPERATION

2-1. GENERAL. A 'Tugit' hoist is an extremely versatile tool and will perform any number of load handling jobs when operated properly and its features are used to advantage. Operation is easy, once you have become acquainted with its convenient controls and their functions. Always practice hoist safety by applying the rules shown in the safety chart on back cover.

NOTE: This equipment is not designed or suitable as a power source for lifting or lowering persons.

2-2. TO RAISE LOAD HOOK.

- Flip finger-tip control lever to "UP" position.
- Turn hand wheel clockwise, as shown in Figure 2-1. This frees load brake.
- Load can now be raised by working the operating handle.

NOTE: If when working the handle you find pressure is required on the upward stroke, turn the hoist over so the handle is on the other side. You'll find it's easier when effort is applied in the downward direction.



Figure 2-1. Turning Handwheel Clockwise - Finger-Tip Lever in "UP" Position



Figure 2-2. Placing Finger-Tip Lever in "DN" Position

2-3. TO LOWER LOAD HOOK.

- Flip finger-tip control lever to "DN" position. Figure 2-2.

b. Load hook will now lower as the handle is actuated.

NOTE: On very light loads, first turn finger-tip control lever to "UP", actuate handle once or twice to make certain handle engages. Then turn lever to "DN" and operate handle.

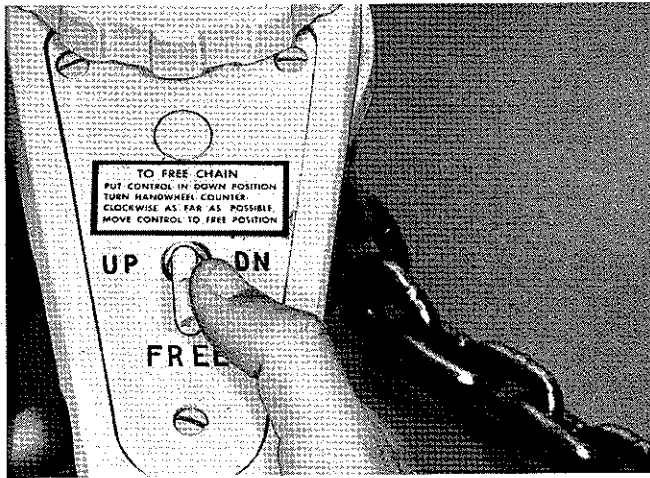
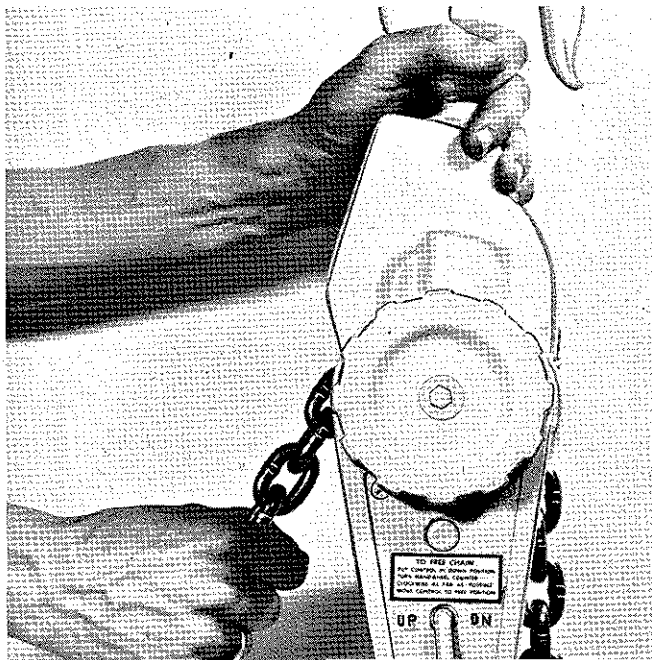

Figure 2-3. Placing Finger-Tip Lever in "FREE" Position

2-4. TO FREEWHEEL CHAIN. Freewheeling allows the load chain to be quickly pulled thru the hoist without operating the handle.

a. Set finger-tip control lever in "DN" position, Figure 2-2, and turn hand wheel counter-clockwise as far as it will go.

b. Move finger-tip lever to "FREE" position, Figure 2-3, and pull chain thru hoist, Figure 2-4.



2-5. "FREE WHEEL" CAUTION.

a. Your 'Tugit' will not "free wheel" if handle is cocked as shown in Figure 2-5. Make certain there is no side thrust or pressure that would prevent handle from turning freely on its pivot.

b. If operating handle works in "UP" direction but not in "DOWN" direction, the load brake is locked-up from previous load. This happens when pulling a tree stump, skidding a heavy machine, or similar jobs where it is unnecessary to relieve the load to detach the 'Tugit' from the load. To correct this condition, place the 'Tugit' on the ground or floor on its side, as shown in Figure 2-6, and strike the handle a sharp blow with your foot. The brake will then unlock. NOTE: The finger-tip lever must be in the "DN" position.

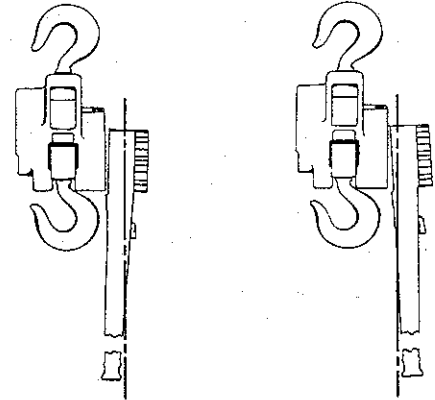

Figure 2-5. Views Showing Operating Handle Cocked

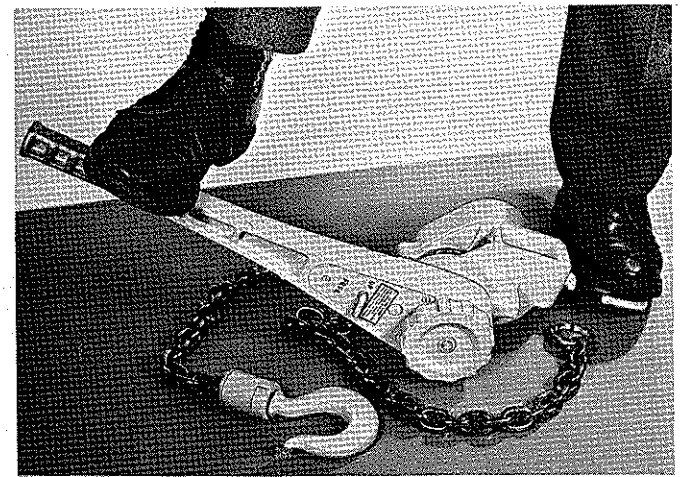

Figure 2-6. Stepping on Operating Handle to Unlock Brake

SECTION III - LUBRICATION

3-1. LUBRICATION OF INTERNAL PARTS. All internal operating parts of 'Tugit' that require lubrication are prelubricated at time of assembly by the factory. Periodic greasing only is recommended, and intervals are dependent upon type of service. See

3-2. LUBRICATION OF EXTERNAL PARTS.

a. Lubricate upper and lower hooks at the swivel point with heavy-duty grease periodically, as required. Use Gredag #83, or equivalent.

NOTE: On 3 ton 'Tugit', also lubricate needle bearings in lower block with a good grade of ball bearing grease.

b. Load chain should be protected with a light film of heavy grease, particularly when subjected to damp or corrosive atmospheres.

SECTION IV - MAINTENANCE

4-1. GENERAL. The following are preventive maintenance steps which should be performed periodically as operating conditions demand. Under most conditions, a yearly maintenance inspection is adequate. The entire hoist should be dismantled and its parts inspected for damage or wear and replaced as necessary. At reassembly, the hoist should be relubricated as outlined in paragraph 6-13. If the hoist has been subjected to extremely adverse conditions, such as excessive dirt, moisture, and misuse by overloading, a more frequent maintenance inspection should be made.

4-2. LOAD BRAKE. If load brake shows a tendency to slip or drag, remove brake parts, as outlined in paragraph 6-5, and inspect brake friction surfaces for

signs of damage, wear, dirt, or an oil film. Contact surfaces of brake flange, ratchet wheel and nut must be free of excessive scoring and clean. Faces of friction washers should be wire brushed and buffed. Replace any worn parts. Load brake pawl should also be checked for signs of wear or damage. NOTE: Be sure to keep brake parts free of oil at reassembly.

4-3. LOAD CHAIN. 'Tugit' link type load chain is made of extremely tough, hard alloy steel. However, it should be inspected periodically for stress marks, rust or corrosion as well as wear caused by abrasive action over a long period of use. Never weld or attempt to repair load chain in the field. Always replace it when damaged or worn using only factory approved chain. Refer to paragraphs 6-3, 6-4 and 6-19.

4-4. HOOKS. Inspect both hooks periodically for evidence of overloading or damage. Check for proper hook opening, Figure 4-1. If hook is opened beyond the given dimension, replace immediately. Refer to Section VI for removal and installation instructions.

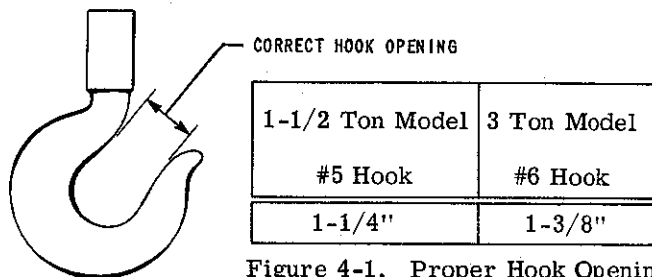

Figure 4-1. Proper Hook Opening

SECTION V - TROUBLE SHOOTING

Condition	Probable Cause	Remedy
1. Load Brake Locked-Up. (Handle works in "UP" but not "DOWN".)	1. Load not lowered after hoist was used for lifting.	1. Unlock load brake as outlined in paragraph 2-5, b.
2. Load Brake Slips. (Hoist will not support loads.)	1. Brake friction surfaces coated with oil, or friction washers glazed. 2. Brake parts damaged or worn. 3. Load chain installed backwards.	1. Remove brake parts and clean surfaces. Wire brush friction faces of friction washers and buff or replace. 2. Remove and inspect brake parts. Replace if necessary. 3. Remove and reinstall. See paragraph 6-19.
3. Load Brake Drags. (Handle works hard.)	1. Excessive dirt inside or internal parts corroded. 2. Brake friction surfaces scored or load gearing damaged from overloading.	1. Disassemble and thoroughly clean as outlined in Section VI. 2. Remove and inspect brake parts and load gearing. Replace damaged or defective parts.
4. Erratic Operation. (Chain gags or jumps a link in lowering direction.)	1. Load chain installed wrong, welds on links facing sprocket. 2. Load brake pawl or ratchet teeth worn or damaged.	1. Remove and reinstall. See paragraph 6-19. 2. Remove load brake parts and inspect pawl and ratchet as outlined in Section VI.

Condition	Probable Cause	Remedy
5. Frame Cracked, or Badly Mutilated.	<ol style="list-style-type: none"> 1. Hoist subjected to excessive overloading. 2. Load chain run thru hoist too far, in lowering, causing welded end link bind against frame. 3. Hoist subjected to extreme angular or side pulls, causing chain to bind on side of frame. 4. Hoist dropped or thrown. 	<ol style="list-style-type: none"> 1. Whenever the frame shows evidence of damage from misuse or rough handling, the hoist should be completely dismantled, all parts inspected and damaged or worn parts replaced, as outlined in Section VI. Always apply the safety rules shown on back cover when using 'Tugit'.
6. Finger Tip Control Lever Sticks.	<ol style="list-style-type: none"> 1. Dirt inside handle or lack of lubrication. 	<ol style="list-style-type: none"> 1. Remove handle cover, clean and lubricate parts as outlined in paragraph 6-13, b.
7. Hoist Will Not Free-Wheel.	<ol style="list-style-type: none"> 1. Improperly operated. 2. Handle cocked when attempting to pull chain thru hoist. 3. Free-wheel cam not correctly installed. 	<ol style="list-style-type: none"> 1. Follow correct operating procedure, Section II. 2. See paragraph 2-5, a. 3. See paragraph 6-18.
8. Hooks Opened.	<ol style="list-style-type: none"> 1. Hoist overloaded. 	<ol style="list-style-type: none"> 1. Replace. Hoist should be inspected for additional damage from overloading.

SECTION VI - DISASSEMBLY & REASSEMBLY

6-1. DISASSEMBLY

6-2. GENERAL. The following disassembly procedure applies to both 1-1/2 ton, single reeved and 3 ton, double reeved 'Tugit' models, except as specifically noted. A complete teardown procedure is given, however, when servicing specific parts, only a partial teardown may be required.

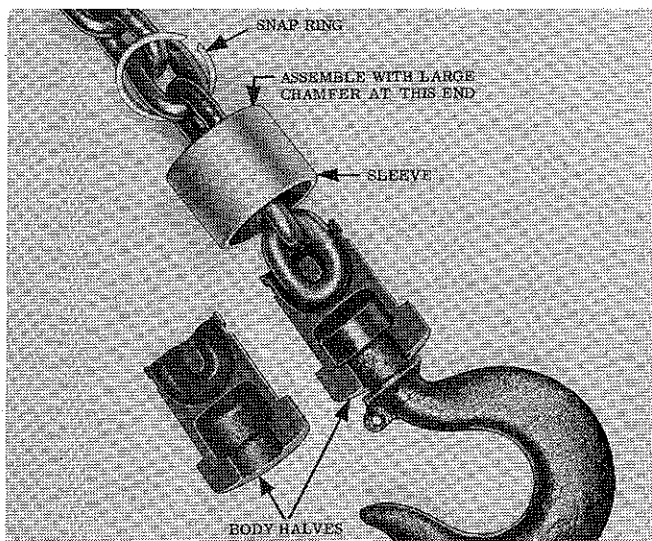

Figure 6-1. Lower Hook Connection - Current 1-1/2 Ton Model Hoists

6-3. REMOVAL OF LOAD CHAIN. (1-1/2 Ton Model)

a. Remove hook from end of load chain. Remove snap ring at top of sleeve, slide sleeve from body halves and separate parts. See Figure 6-1. Early models have two Spirolox retaining rings holding lower block sleeve. See Figure 6-2. To remove, carefully unwind rings using knife blade or other suitable tool.

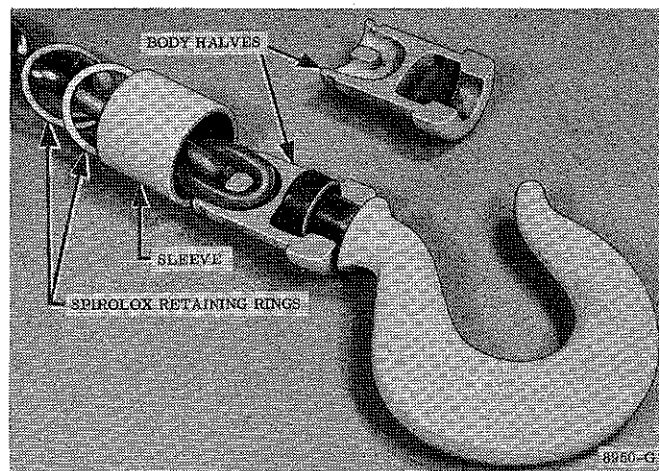

Figure 6-2. Lower Hook Connection - Early 1-1/2 Ton Model Hoists

b. Place hoist in freewheel position (par. 2-4) and pull out load chain. The round end link on end of chain, opposite hook end, will not pass thru hoist, so pull hook end thru.

6-4. REMOVAL OF LOAD CHAIN. (3 Ton Model)

a. At anchor end of load chain, Figure 6-3, remove set screw and pull out chain anchor pin. A hole is provided in end of pin to facilitate its removal. When pin is out, the chain and anchor can be lifted out.

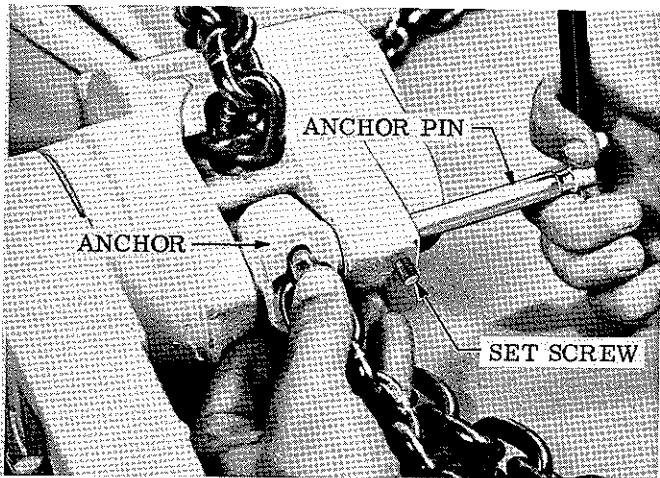

Figure 6-3. Removing Load Chain Anchor Pin using Tool for Pulling

b. Remove lower block and hook assembly from load chain and lay to one side for further disassembly.

c. Remove load chain from hoist as outlined in paragraph 6-3, b.

6-5. REMOVAL OF OPERATING HANDLE AND LOAD BRAKE PARTS,

can now be removed from the outer face of the brake nut by removing two socket head cap screws and lifting off plunger housing.

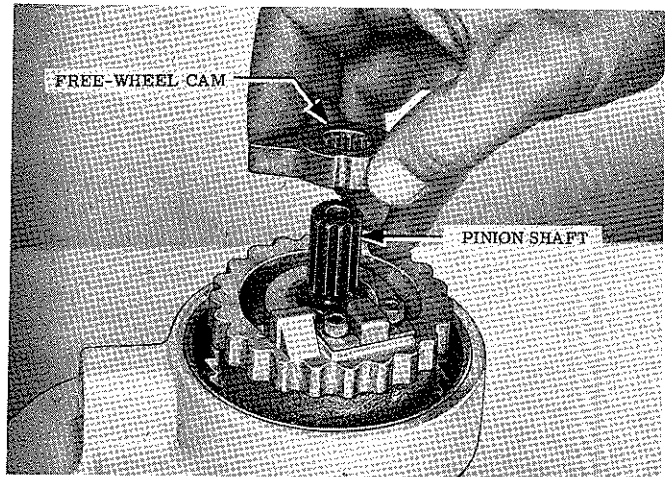
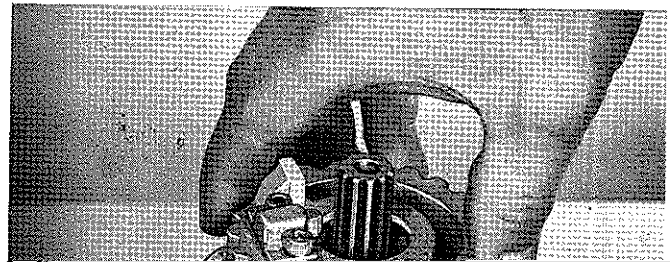

Figure 6-5. Removing Free-Wheel Cam



h. Remove internal retaining ring from outside end of pawl bore, using Truarc pliers (size #1) as shown in Figure 6-8, and take out pawl spring disc. Also press out pawl sleeve.

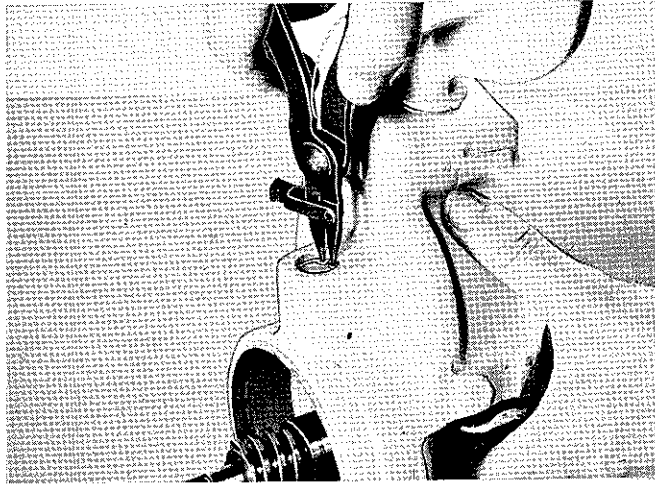

Figure 6-8. Removing Internal Retaining Ring from Brake Pawl Bore

6-6. REMOVAL OF LOAD GEARING.

- a. From opposite side of hoist, remove 3 fillister head screws and lift off rear cover. If necessary, loosen by tapping with a soft mallet.
- b. Remove pinion bearing from pinion shaft and bore in frame. Bearing can be started but of bore by tapping on end of shaft as shown in Figure 6-9.

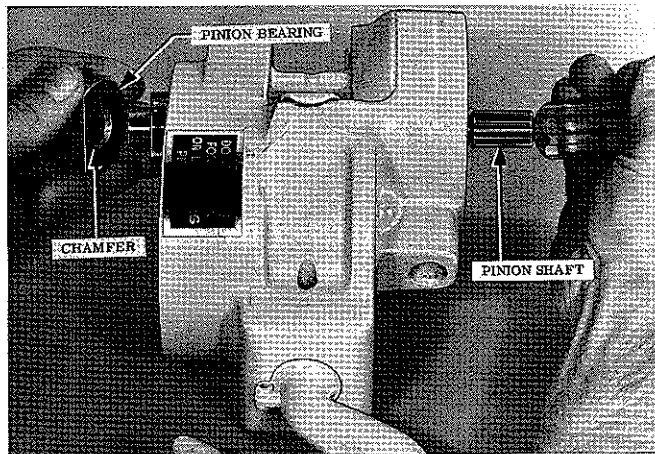

Figure 6-9. Removing Pinion Bearing from Frame and Pinion Shaft

c. Load gearing can now be removed. First lift out chain sprocket with integral gear. Then remove pinion shaft and pinion thrust bearing. The bearing will come out with the shaft and is of special two-piece design for removal from shaft. See Figure 6-10. Separate bearing halves and remove from shaft.

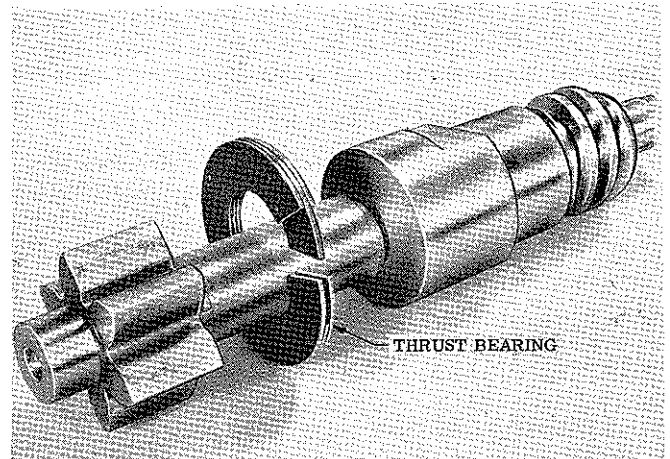

Figure 6-10. Pinion Shaft and Two-Piece Thrust Bearing

6-7. REMOVAL OF UPPER HOOK.

- a. Align groove pin in hook nut with hole in side of frame and drive out pin with drift punch. If pin is only partially driven out it will serve to hold nut while hook is being unscrewed.
- b. Unscrew and remove hook, nut and machinery bushing. Keep hook and nut together, as they are not interchangeable with others.

6-8. DISASSEMBLY OF OPERATING HANDLE.

- a. Remove 3 fillister head screws and lift handle cover from handle. The thumb lever and spring will come out with cover. Remove spring and lever from cover.
- b. Remove 2 bearing caps and handle pawl from handle.
- c. Remove flange bearing from handle.

6-9. DISASSEMBLY OF LOWER BLOCK (3 Ton Model)

- a. Using a short length of 1/8 inch drill rod, or suitable drift punch, drive roll pin from one end of sprocket shaft in lower block.
- b. Press shaft from block and remove sprocket and 2 washers.
- c. Remove 2 needle bearing assemblies from sprocket bore.
- d. Align groove pin in hook nut with hole in block body and drive out pin with a drift punch. See Figure 6-11.

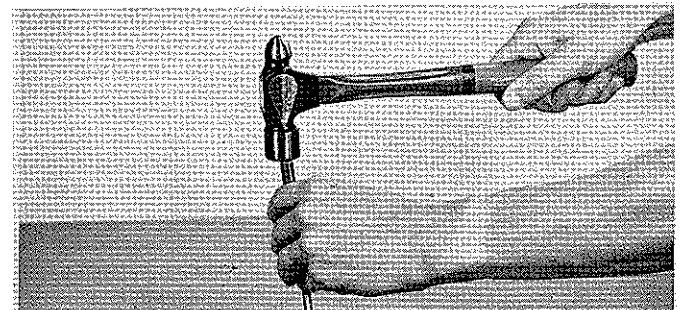

e. Unscrew and remove hook, nut and thrust washer. Keep hook and nut together, as they are not interchangeable with others.

6-10. REASSEMBLY.

6-11. GENERAL. The procedure to be followed for reassembly is in reverse order of the disassembly steps outlined above. There are however, certain precautionary steps that must be taken, as outlined in paragraphs 6-12 thru 6-20 below.

6-12. CLEANING AND INSPECTION OF PARTS.

a. Before assembly, all parts should be thoroughly cleaned and inspected to determine their serviceability.

b. Replace parts that are excessively worn or damaged.

6-13. LUBRICATION OF PARTS

a. Lubricate upper and lower hooks with heavy-duty grease, Gredag #83 or equivalent. Apply on hook shanks and surfaces between hook, frame, machinery bushing and nut. On 3-ton lower block, apply a good grade of ball bearing grease to needle bearings in sprocket.

b. Lubricate all moving parts in frame and handle, except brake friction surfaces and oilite bearings, with a light film of a good grade of gear grease, Shell EP-2 Alvania grease, or equivalent.

NOTE: It is extremely important that load brake friction surfaces be kept dry, as an oily film may cause slippage, thereby, permitting a load to drop.

c. Bearing surfaces that operate in the oilite bearings and screw threads of brake nut should be lightly oiled.

6-15. INSTALLING UPPER HOOK. Instructions for installing lower hook and nut in paragraph 6-14 above, also apply to upper hook and nut.

6-16. INSTALLING LOAD BRAKE PAWL. When installing pawl sleeve and brake pawl in frame, the notches on sides of sleeve and pawl should be aligned with roll pin hole in frame.

6-17. INSTALLING LOAD GEARING.

a. Before load gearing is installed, be certain chain guide is properly seated in frame.

b. When installing pinion bearing, be certain to position it so chamfer in bore faces the pinion gear. See Figure 6-9. The flat on side of bearing must be perfectly aligned with cover pilot bore in frame, as shown in Figure 6-13.

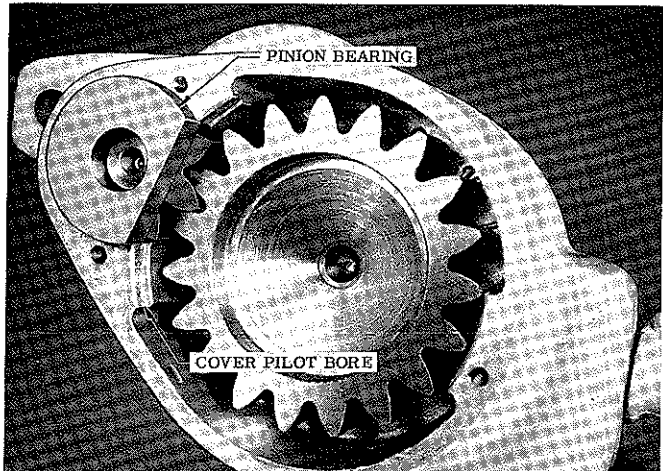

b. After installing load brake nut on pinion shaft, turn nut counter-clockwise thru several clicks of the brake pawl to bring brake friction surfaces into contact before free-wheel cam is installed.

c. Place cam over end of shaft with lug on cam clockwise of stop on load brake nut as shown in figure 6-15. Detent notch on cam should be positioned as close as possible to plunger, but should not engage plunger.

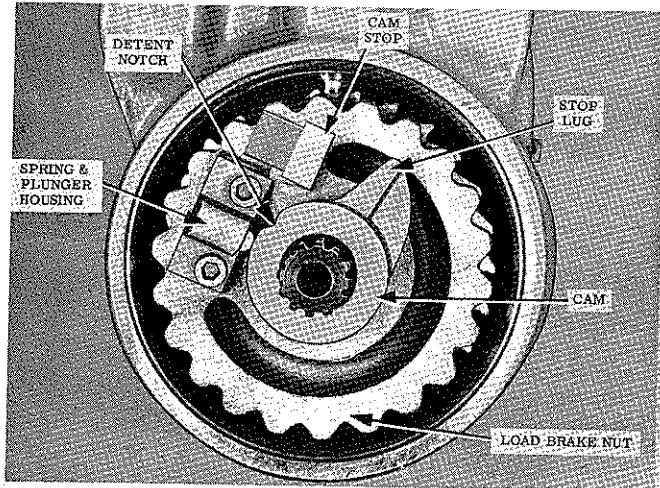

Figure 6-15. Assembled View Showing Correct Position for Free-Wheel Cam

d. With a small screw driver (Figure 6-16) depress plunger and push cam down, tight against shaft shoulder.



NOTE: If it comes out of free-wheel too easily, increase the tension on plunger by loosening housing retaining screws and moving housing toward the cam. Retighten screws securely.

f. When operation appears satisfactory, remove hand wheel and proceed with assembly of hoist.

6-19. INSTALLING LOAD CHAIN. When installing load chain it is possible to feed it into the wrong side of hoist, which will result in a reversed action and load brake will not function. To avoid this, lay hoist on work bench in the position shown in Figure 6-17, hand wheel side at your left. Then with control lever in "FREE" position, run chain thru, using hand wheel. Be sure welded side of chain links face up so they do not enter chain pockets in sprocket, and chain is not twisted.

6-20. CHECK FREE-WHEEL OPERATION

a. Move thumb lever on operating handle to "DN" position and rotate hand wheel counter-clockwise (shown by arrows on wheel) to free load brake.

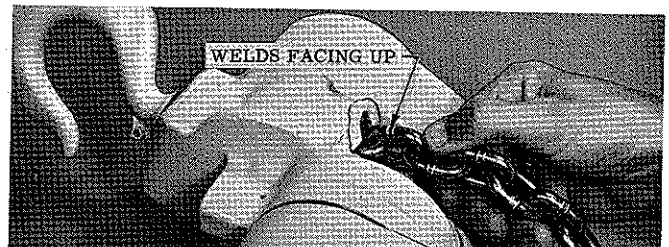

SECTION VII. PARTS LIST

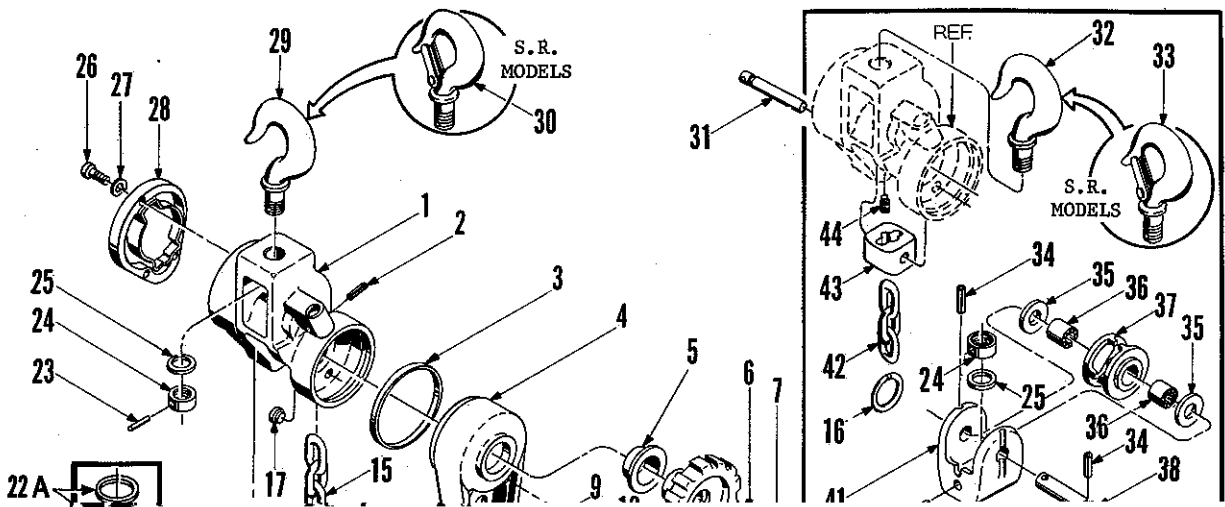
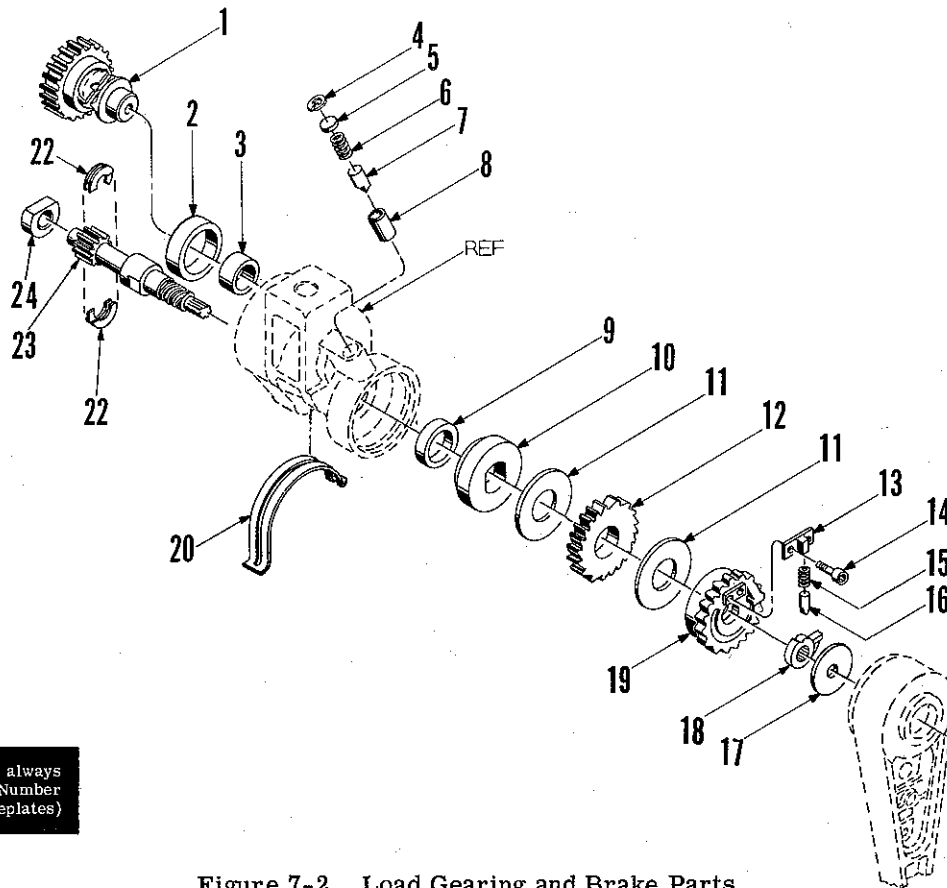

FIGURE 7-1 FRAME AND EXTERNAL PARTS (con'td.)

Ref. No.	Part Number	Description	Qty. Req'd.	
			1-1/2 Ton	3 Ton
	219885-1	Lower Block Ass'y. - Plain Hook (Standard)	1	-
	219885-2	Lower Block Ass'y. - Safety Hook (Spark & Corrosion Resistant)	Opt.	-
18	***	Body Half - Lower Block (Models 503700 and 503702)	2	-
	***	Body Half - Lower Block (Models 505110 and 505111)	2	-
\$19	203691-1	Lower Hook - Plain - No. 5 (Standard)	1	-
20	203691-6	Lower Hook - Safety Type - No. 5 (Spark & Corrosion Resistant)	Opt.	-
21		Sleeve - Lower Block		
	***	(Standard Models 505110)	1	-
	***	(Standard Models 503700)	1	-
	108400-1	(Spark and Corrosion Resistant Model 505111)	Opt.	-
	108400-1	(Spark and Corrosion Resistant Model 503702)	Opt.	-
22	108398-1	Snap Ring (Models 505110 and 505111)	1	-
22A	104137-1	Retaining Ring - Spirolox (Models 503700 and 503702)	2	1
23	100996-55	Groove Pin	1	2
24	**	Hook Nut	1	2
25	105806-1	Machinery Bushing	1	2
26	103771-11	Hex Hd. Bolt - #10-24 x 5/8	5	5
27	No. 1022	Std. Lockwasher - No. 10	6	6
28	306576-1	Cover	1	-
	306576-2	Cover	-	1
\$29	212117-1	Upper Hook Ass'y. - Plain - No. 5 (Standard)	1	-
30	212117-4	Upper Hook Ass'y. - Safety Type - No. 5 (Spark & Corrosion Resistant)	Opt.	-
31	104498-1	Anchor Pin - Load Chain	-	1
\$32	212116-1	Upper Hook Ass'y. - Plain - No. 6 (Standard)	-	1
33	212116-6	Upper Hook Ass'y. - Safety Type - No. 6 (Spark & Corrosion Resistant)	-	Opt.
	308616-2	Lower Block Ass'y. - Plain Hook - (Standard)	-	1
	308616-4	Lower Block Ass'y. - Safety Hook - (Spark & Corrosion Resistant)	-	Opt.
34	101716-24	Roll Pin - 1/8 x 1 lg.	-	2
35	102480-4	Washer	-	2
36	No. 9627	Needle Bearing	-	2
37	306682-1	Sprocket	-	1
38	104495-1	Shaft - Sprocket	-	1
\$39	212116-1	Lower Hook Ass'y. - Plain - No. 6 (Standard)	-	1
40	212116-6	Lower Hook Ass'y. - Safety Type - No. 6 (Spark & Corrosion Resistant)	-	Opt.
41	306681-1	Lower Block Body	-	1
42		Load Chain Ass'y. -		
	*226028-6	(Standard)	-	1
	*209156-26	(Spark & Corrosion Resistant)	-	Opt.
43	209181-1	Anchor - Load Chain	-	1
44	103952-5	Set Screw - Nylok - 1/4-20 x 3/8	-	1

NOTES: * Chain assemblies listed are for hoists with standard 4 ft.-6 in. lifts.
Specify lift required when ordering for hoists with longer lifts.
** Hook nuts are not interchangeable. They are available only with hook as an assembly.
*** Items 18 and 21 furnished in kit only. Order Part No. 112622-1. Snap ring 22 is included in kit.
§ Safety latch for Standard Models available separate from hook. Order Part No. 113307-5 for Size 5 hook; Part No. 113307-5 for Size 6 hook.

NOTES



When ordering parts, always give Model and Catalog Number of Holst. (See nameplates)

8869 A

Figure 7-2. Load Gearing and Brake Parts
All 1-1/2 and 3 Ton Models

Ref. No.	Part Number	Description	Qty. Req'd.
1	306580-1	Sprocket	1
2	104028-6	Bearing - Oilite	1
3	104028-8	Bearing - Oilite	1
4	104038-2	Retaining Ring - Internal	1
5	104473-1	Disc - Pawl Spring	1
6	104464-1	Spring - Pawl	1
7	104467-1	Pawl - Load Brake	1
8	104465-1	Sleeve - Pawl	1
9	104028-7	Bearing - Oilite	1
10	209119-1	Brake Flange	1
11	104468-1	Friction Washer - Brake	2
12	209120-1	Ratchet - Load Brake	1
13	209139-1	Housing - Plunger	1
14	103920-12	Soc. Hd. Cap Screw #10-24 x 3/8	2
	104045-10	Internal Tooth Lockwasher No. 10	2
15	104250-1	Lockout Spring	1
16	100682-1	Plunger - Lockout Spring	1
17	106082-1	Thrust Washer - Handle	1
18	212836-1	Free-Wheel Cam	1
19	213393-1	Load Brake Nut	1
20	307557-1	Chain Guide	1
21	Reserved		-
22	209126-1	Thrust Bearing - Pinion	2
23	309329-1	Pinion Shaft	1
24	104466-1	Pinion Bearing	1

SECTION VIII. INSTRUCTIONS FOR CONVERTING 3 TON CONVERTIBLE MODEL

8-1. GENERAL. The 3 ton 'Tugit' Lever Operated Hoist Convertible Model is identical to standard 3 ton models except for a Quick Disconnect Chain Anchor Fitting. This special fitting makes it possible to convert the 3 ton Double Line Model (Figure 8-1) to a 1-1/2 ton Single Line Model (Figure 8-2) in a matter of seconds without the use of tools.

8-2. INSTRUCTIONS

- a. To convert hoist from 3 ton Double Line to 1-1/2 ton Single Line, position hoist as shown in Figure 8-3.
- b. Depress and hold Release Pin and withdraw Frame Anchor Pin as shown in Figure 8-4.
- c. Withdraw Quick Disconnect Fitting and reinstall Frame Anchor Pin as shown in Figure 8-5.

NOTE: To convert a hoist from 1-1/2 ton Single Line to a 3 ton Double Line merely reverse the above procedure.

* * * * *

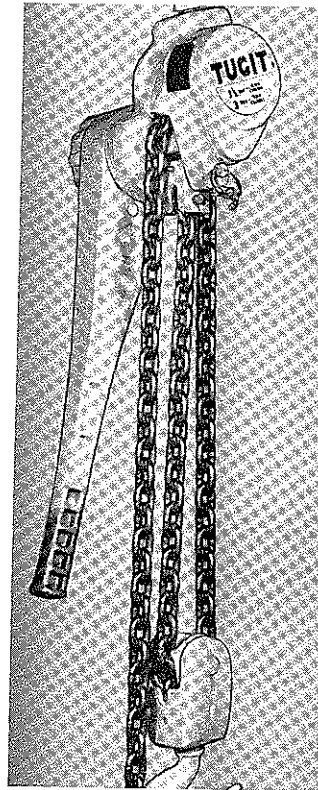

Figure 8-1.
3 Ton Double Line
Convertible Model

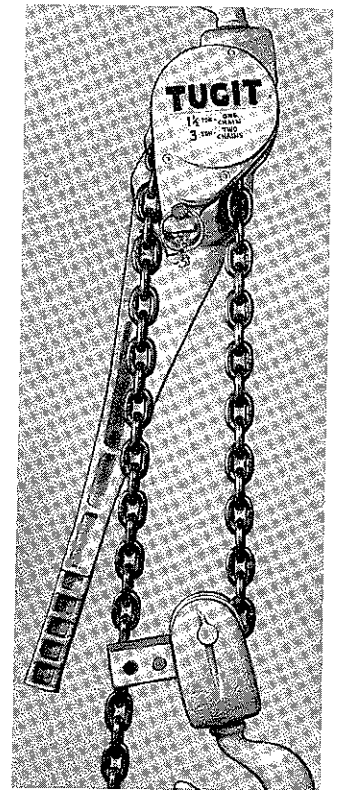

Figure 8-2.
Converted to 1-1/2 Ton
Single Line Model

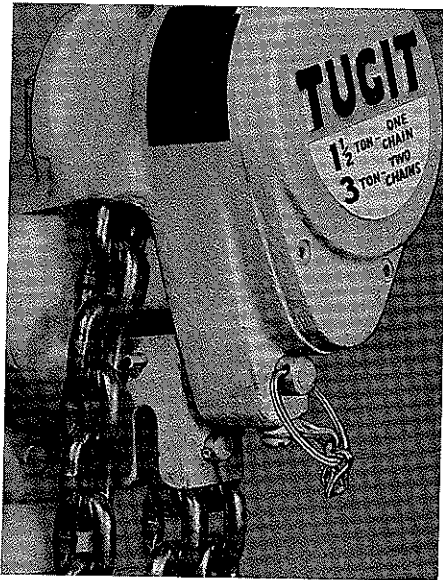

Figure 8-3.

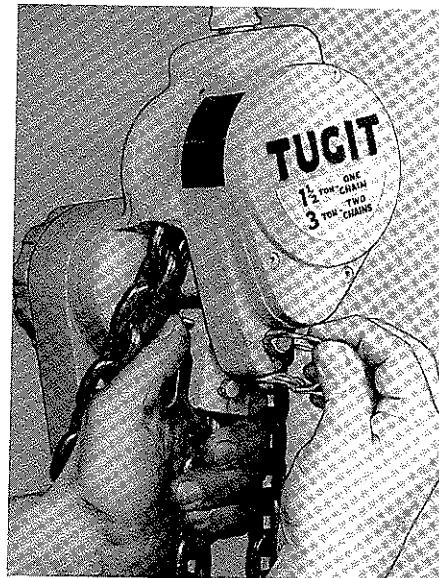

Figure 8-4.

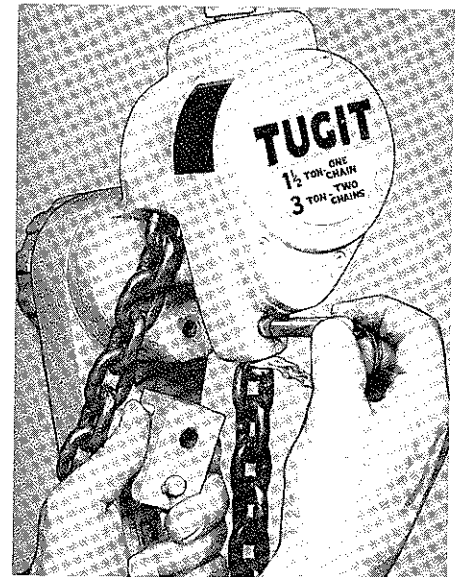

Figure 8-5.

NOTES

SECTION IX. PARTS LIST FOR 3 TON CONVERTIBLE MODEL

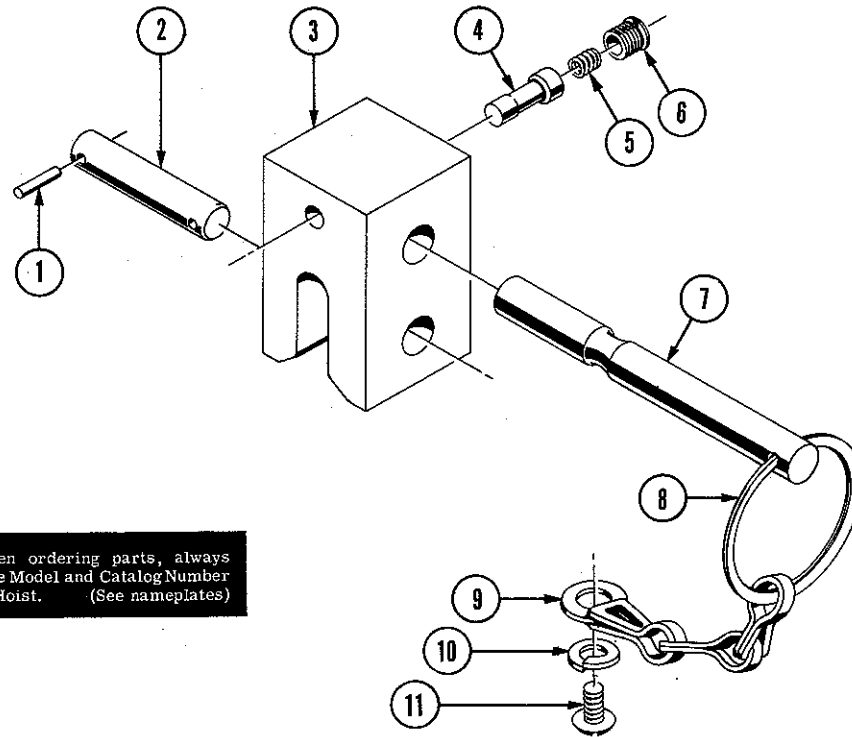

Figure 9-1. Convertible Model Conversion Parts

Ref. No.	Part Number	Part Name	Qty. Req'd
1	101716-22	Rollpin 1/8 x 3/4	2
2	106108-1	Pin - Lower	1
3	309403-1	Chain Anchor Body	1
4	212895-1	Plunger	1
5	104250-3	Spring (Colored Red)	1
6	104251-1	Spring Plug	1
7	212894-1	Pin - Upper	1
8	106478-1	Ring	1
9	106206-1	Chain	1
10	104032-1	Lockwasher	1
11	NO-11954	Rd. Hd. Mach. Screw 1/4-20 x 3/8	1
12	309641-1	End Cover - Nameplate (Not Shown)	1

NOTE: For complete parts listing, refer to Figures 7-1 and 7-2. All parts, other than those illustrated and listed above, are the same as parts shown for 3 ton Standard Models.

NOTES

LEVER HOIST SAFETY CHART

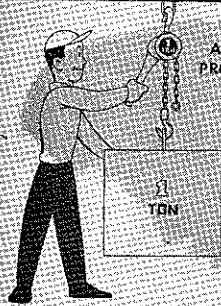

ALWAYS USE THE PROPER SIZE HOIST

NEVER STAND OR WALK UNDER LOAD

NEVER OVERLOAD A HOIST

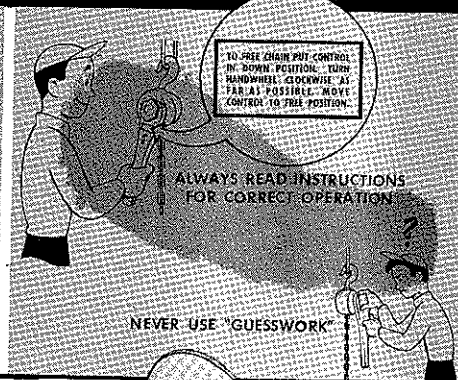
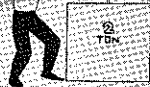

ALWAYS READ INSTRUCTIONS FOR CORRECT OPERATION

NEVER USE "GUESSWORK"

TO FREE CHAIN PUT CONTROL IN DOWN POSITION. TURN HANDWHEEL CLOCKWISE AS FAR AS POSSIBLE. MOVE CONTROL TO FREE POSITION.

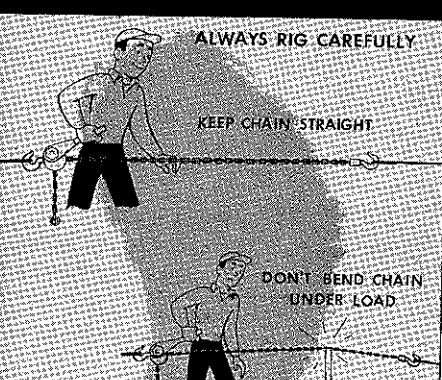

ALWAYS RIG CAREFULLY

KEEP CHAIN STRAIGHT

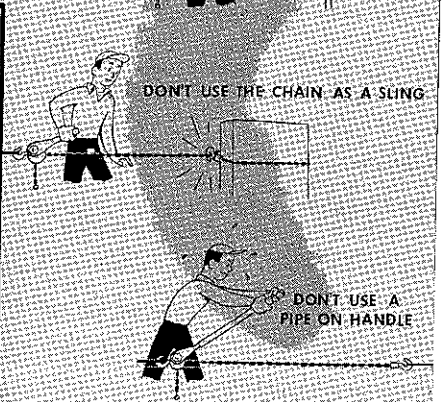

DON'T BEND CHAIN UNDER LOAD

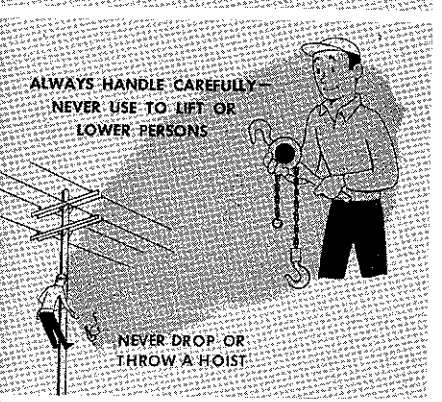

DON'T USE THE CHAIN AS A SLING

DON'T USE A PIPE ON HANDLE

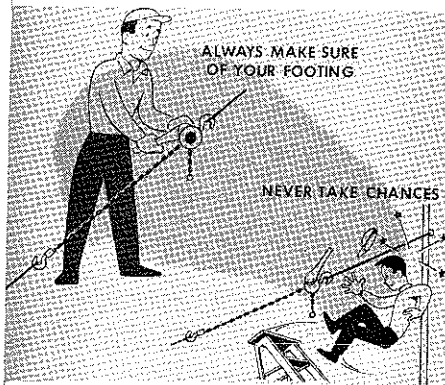

ALWAYS MAKE SURE OF YOUR FOOTING

NEVER TAKE CHANCES

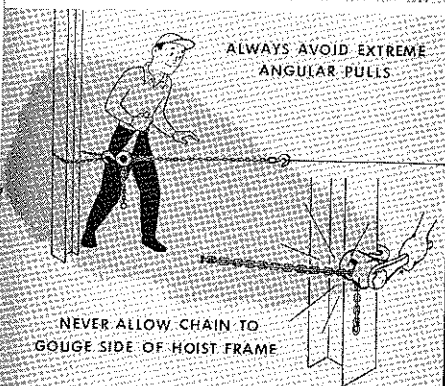

ALWAYS AVOID EXTREME ANGULAR PULLS

NEVER ALLOW CHAIN TO GOUGE SIDE OF HOIST FRAME

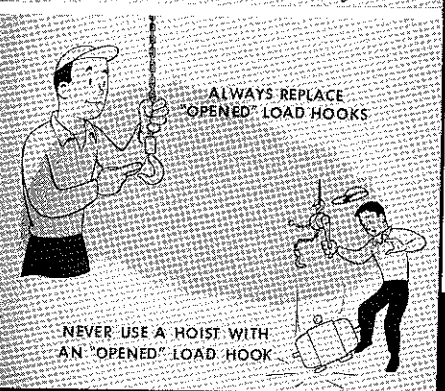

ALWAYS REPLACE "OPENED" LOAD HOOKS

NEVER USE A HOIST WITH AN "OPENED" LOAD HOOK

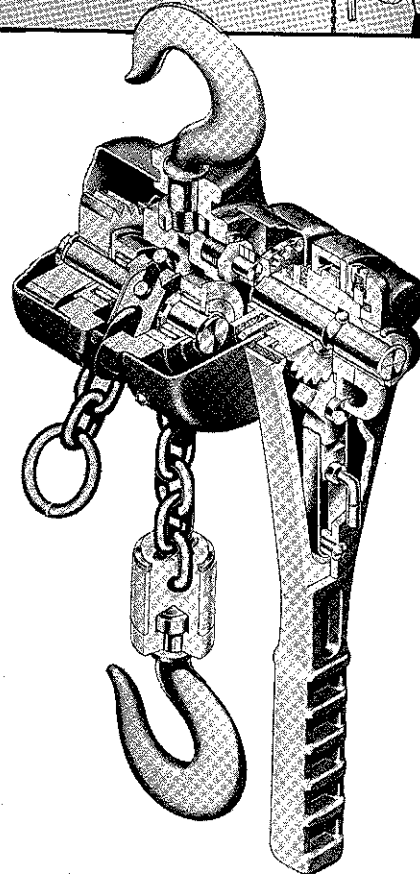

A lever operated hoist is a precision built tool and should be treated as such. Like any piece of precision equipment, it gives the best performance only when kept in top condition and when properly operated.

To get the most out of your hoist - and for safety - handle it carefully, always use the correct operating procedure, and give it regular inspection and maintenance.

Follow the rules illustrated here - they'll make hoist-safety a habit.

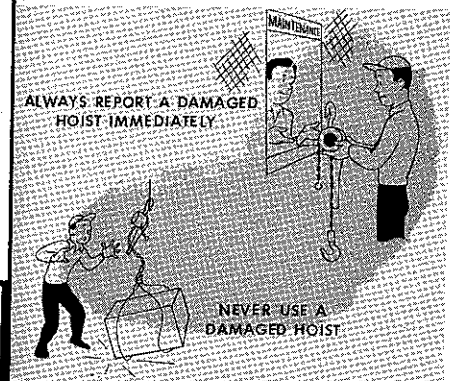

ALWAYS REPORT A DAMAGED HOIST IMMEDIATELY

NEVER USE A DAMAGED HOIST

